

# SF17 Multi Color RGBW Silicone LED Linear Flex

SF17-24V-5050-84-RGBW-V1

## Specification

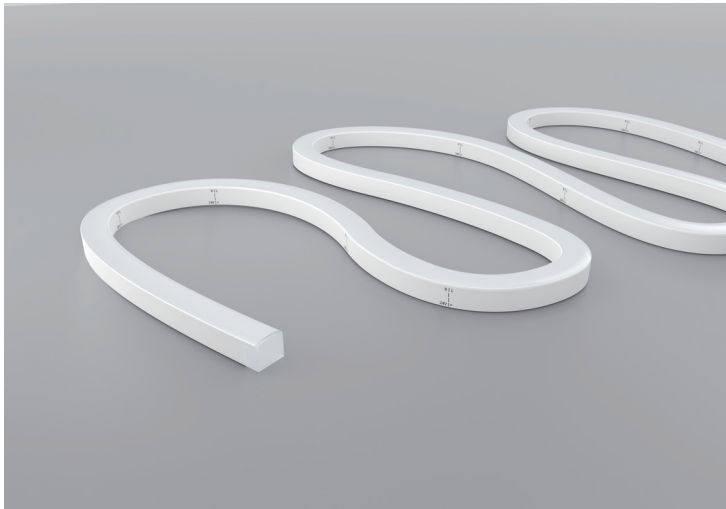

## Technical Parameters

Electrical	
Input Voltage	24V DC
Power Consumption	20W/m
Physical	
LED Count	84 LEDs/m
Cutting Unit	7 LEDs
Cutting Unit Length	83.3mm
Minimum Bend Diameter	150mm
Output	
LED Light	Epistar SMD LED 5050
Color	RGBW(2700K/3000K/4000K/5000K)
Max Run Length*	
Single Feed	7 M
Double Feed	14 M
Beam Angle	120°
Lumen Maintenance	70,000 Hours L70 @ 25°C 50,000 Hours L70 @ 50°C
Temperature Ranges	
Installation	0°C to 50°C
Operating	-40°C to 55°C
Dependability	
Warranty	5 Years Warranty
IP Rating	IP68 Wet location submersible <2m

Emitting Color	Lumen Output
Red	55lm/m
Green	187lm/m
Blue	29lm/m
RGB(White)	432m/m
3000K	166m/m

## Illuminance Distribution

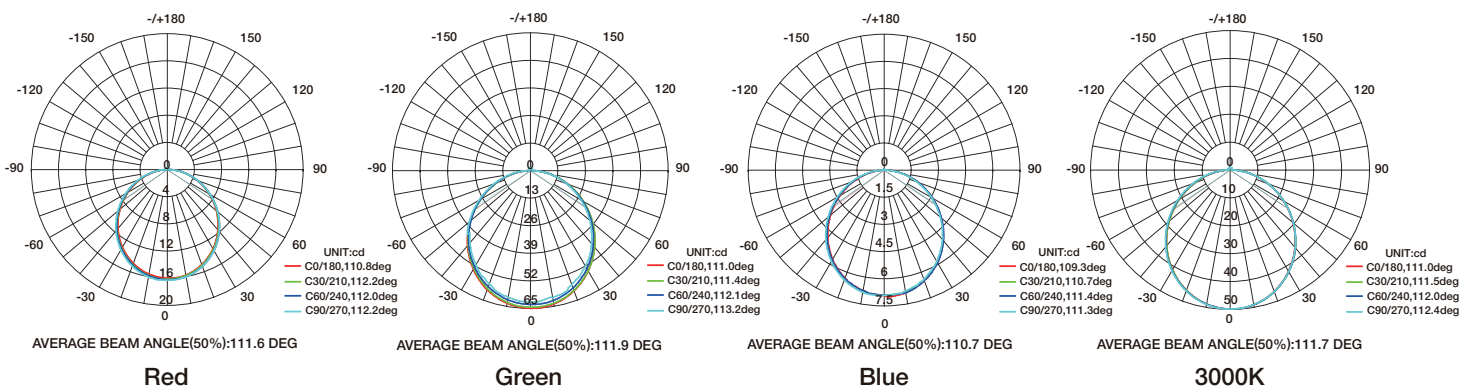

# SF17 Multi Color RGBW Silicone LED Linear Flex

## Connection

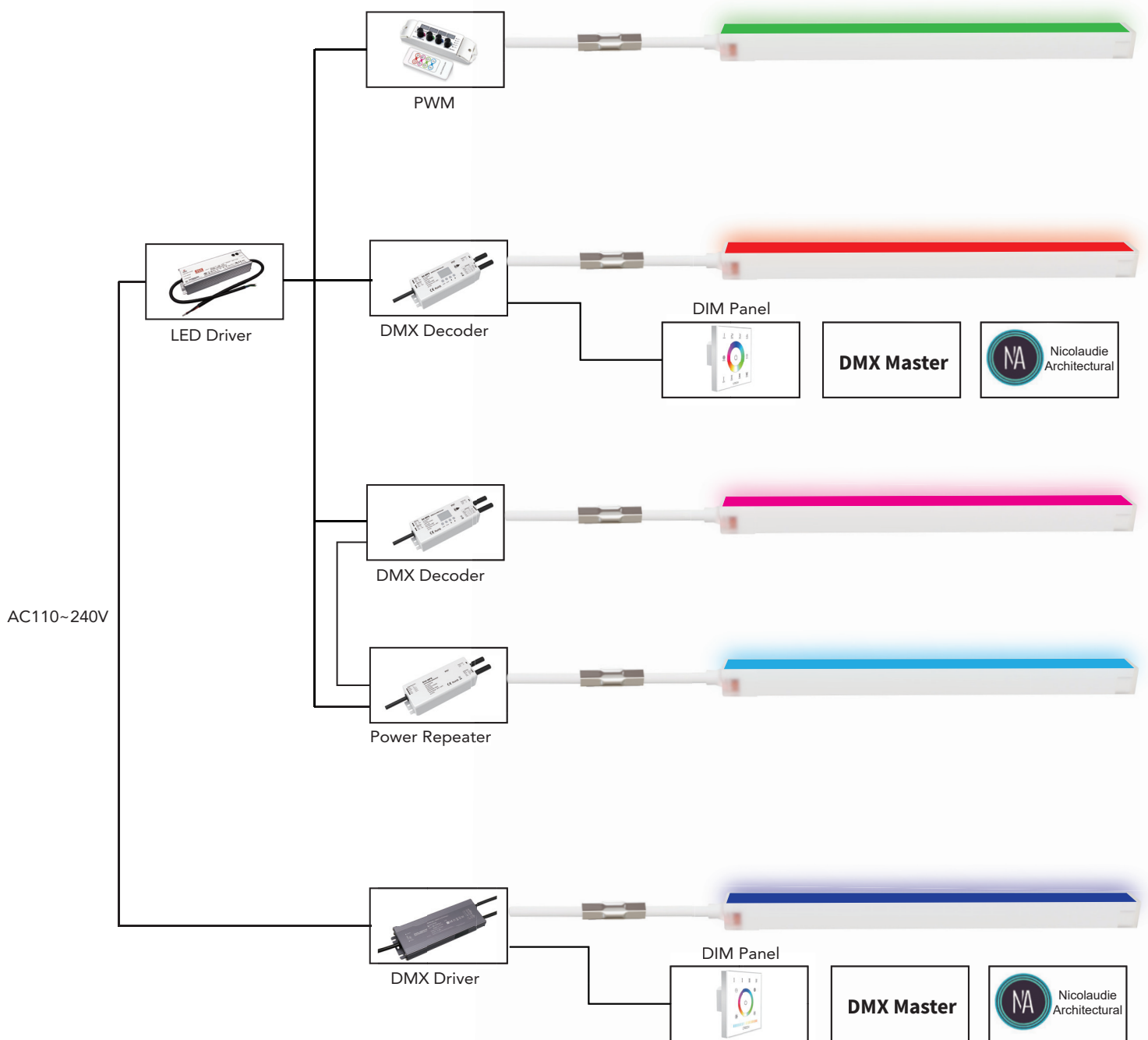

# SF17 Configuration and Accessories

Mold injection Connector

(IP68 Factory Assembly Only)

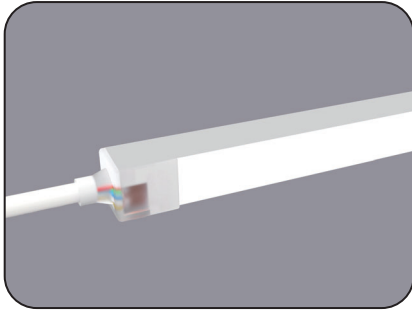

Direct Entry Connector  
 MJ-SF17-RGBW-D01/02/03  
 MJ-SF17-RGBW-D01SM  
 MJ-SF17-RGBW-D02SF  
 MJ-SF17-RGBW-D03SFM

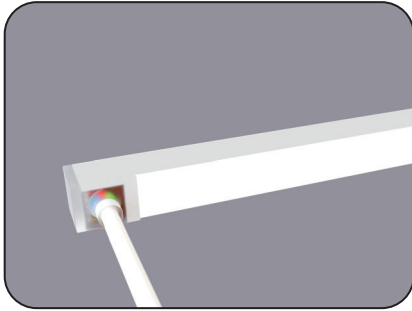
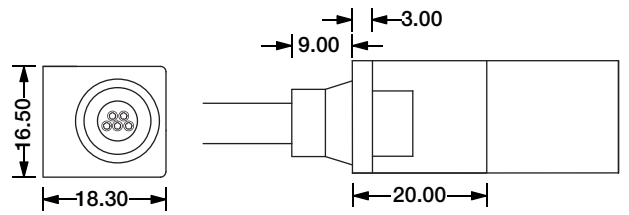

Side Entry Connector  
 MJ-SF17-RGBW-S01/02/03  
 MJ-SF17-RGBW-S01SM  
 MJ-SF17-RGBW-S02SF  
 MJ-SF17-RGBW-S03SFM

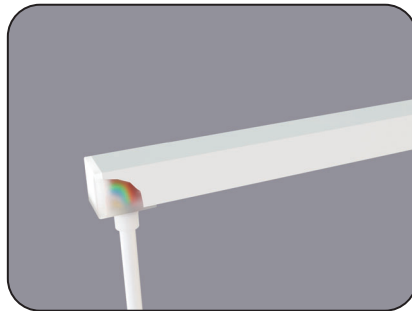
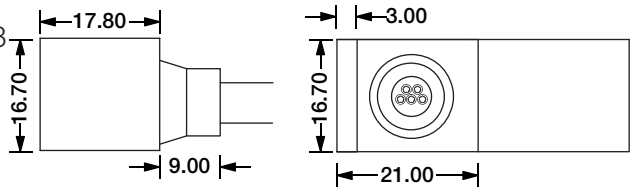

Bottom Entry Connector  
 MJ-SF17-RGBW-B01/02/03  
 MJ-SF17-RGBW-B01SM  
 MJ-SF17-RGBW-B02SF  
 MJ-SF17-RGBW-B03SFM

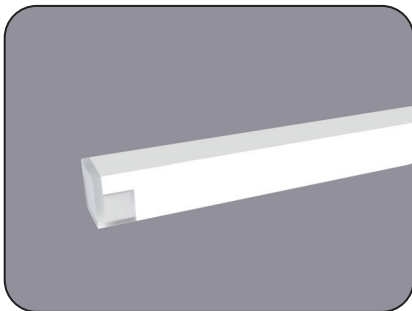
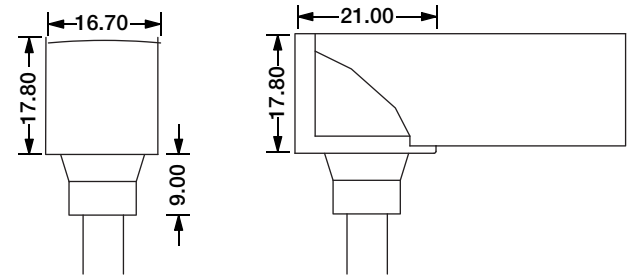

End Cap

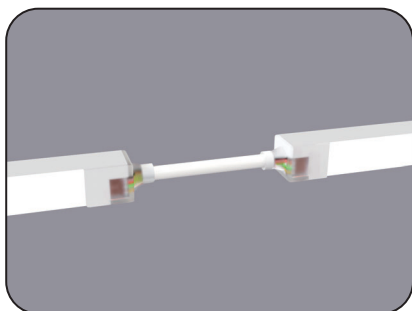
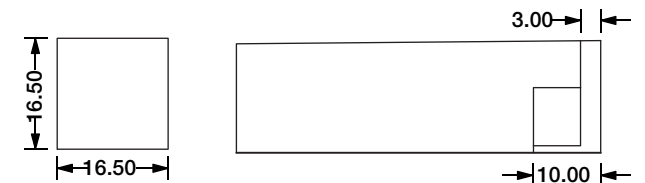

Jumper  
 MJ-SF17-RGBW-D-JC

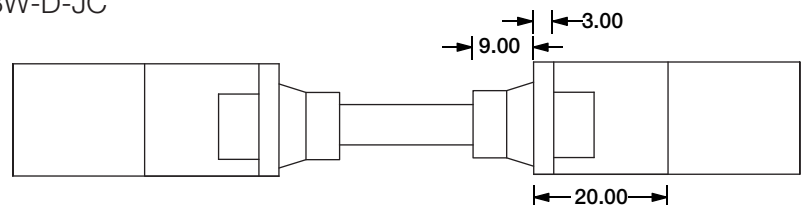

# SF17 Configuration and Accessories

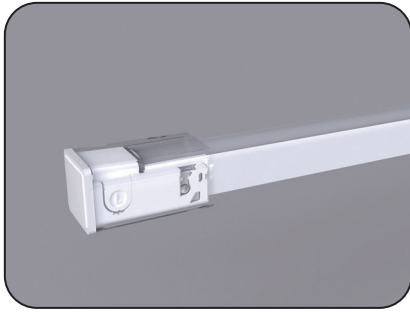

DIY Snap End Cap  
DIY-SN-END-17-D-01/02

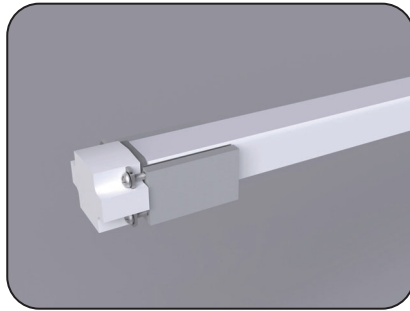
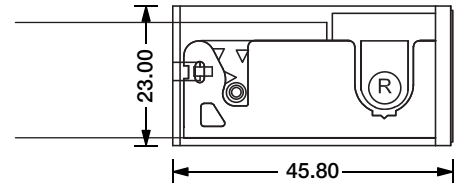
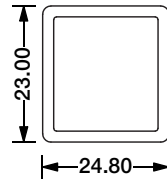

DIY Screw End Cap  
DIY-SC-END-16

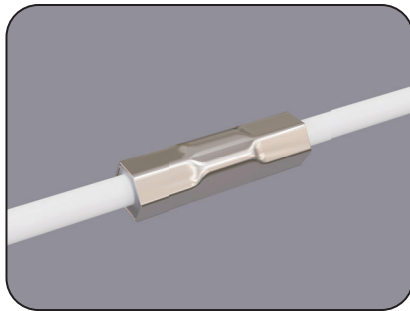
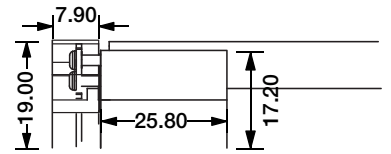
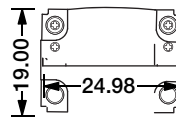

Waterproof Interrupter

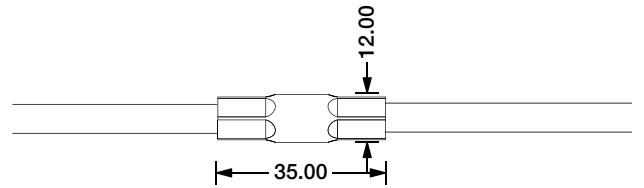

Male Connector  
M12-M-5C-20AWG-D6-W-0327-S

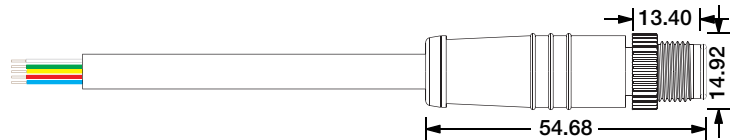

Female Connector  
M12-F-5C-20AWG-D6-W-0327-S

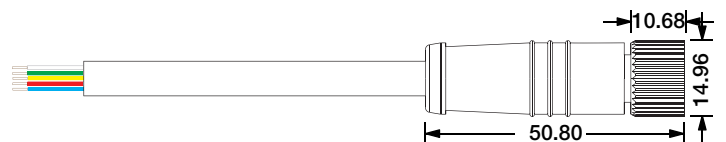

# SF17 Configuration and Accessories

---

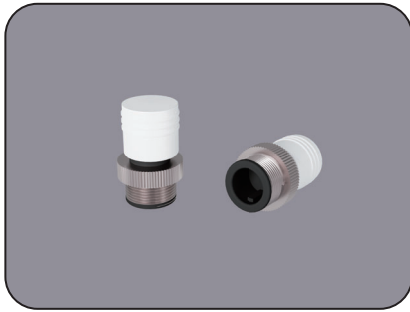

Male Connector End Cap  
SYZ-EC-M12-M

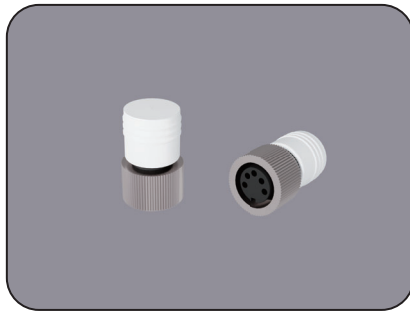
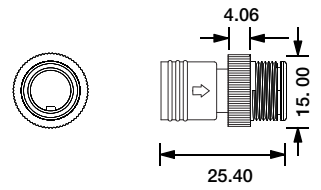

Female Connector End Cap  
SYZ-EC-M12-F-5C

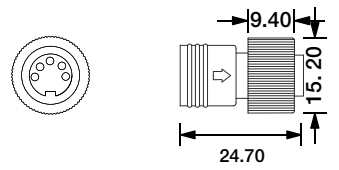

# LED Linear Flex Mounting Channel

## 1. Aluminum Channel

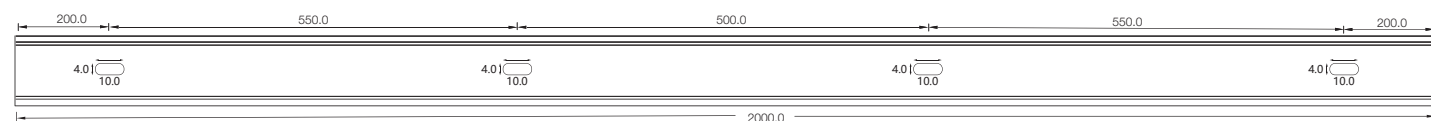
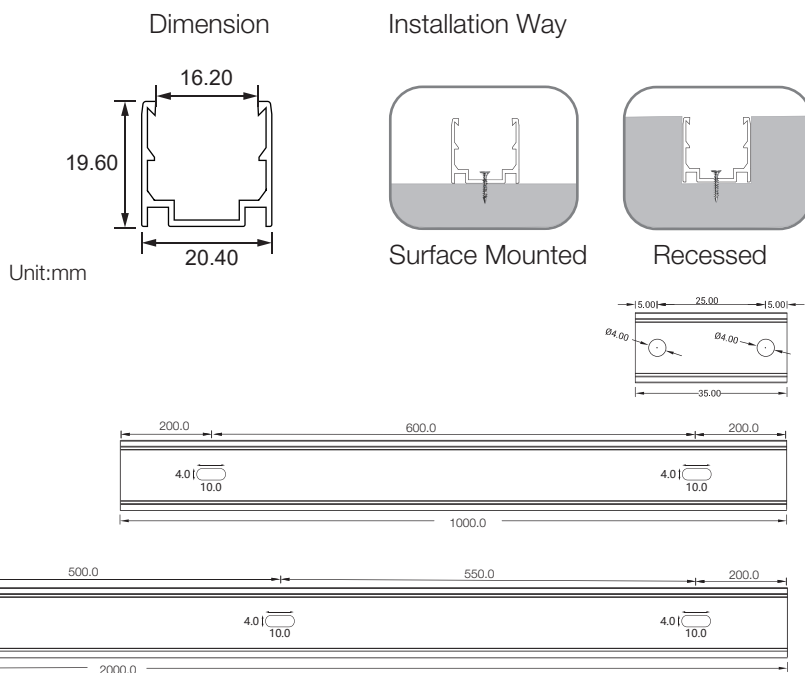
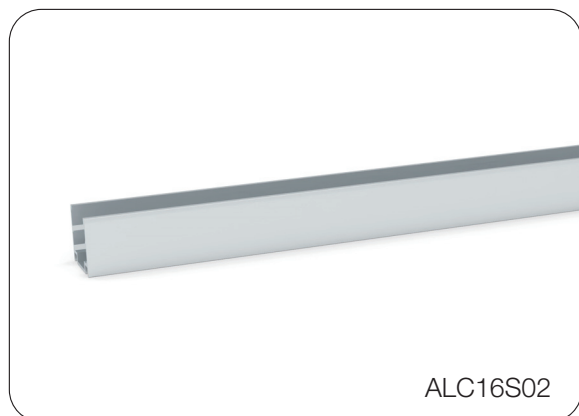

Model	W x H(mm)	Standard Length	Screw Holes	Holes Numbers	Suitable Product
ALC16S02-035	20.40*19.60	35mm	Φ4.0mm	2	SF17
ALC16S02-100		1000mm	○4.0mm	2	SF17
ALC16S02-200		2000mm	○4.0mm	4	SF17

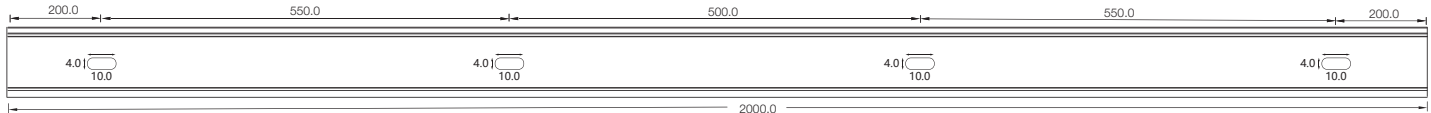
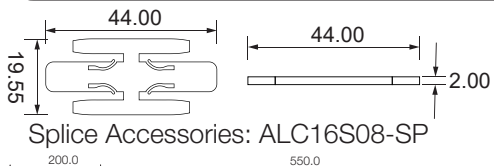
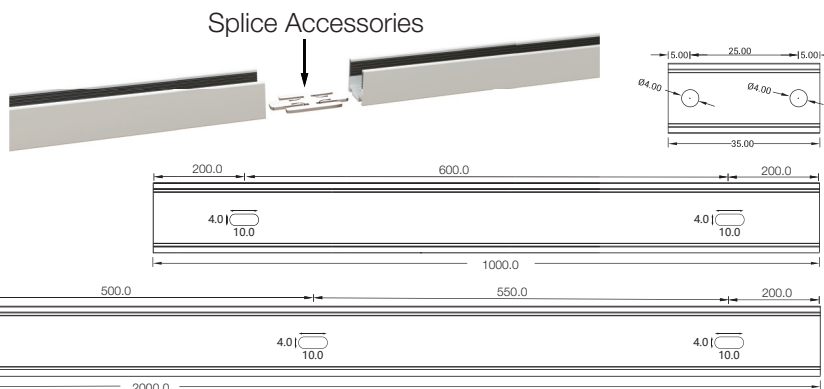
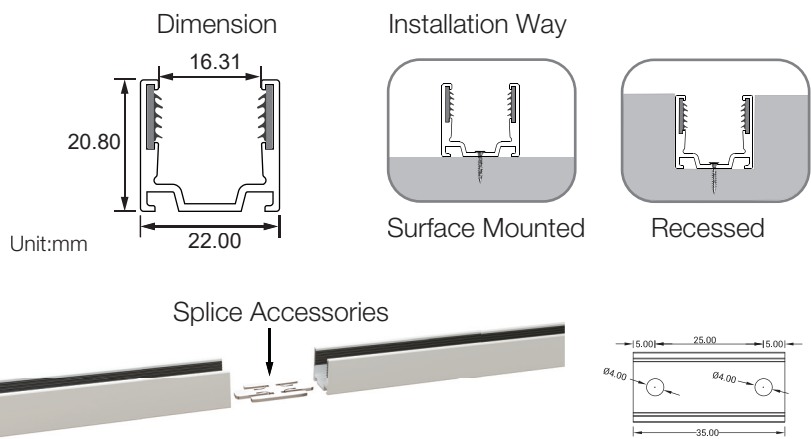

Model	W x H(mm)	Standard Length	Screw Holes	Holes Numbers	Suitable Product
ALC16S08-035	22.00*20.80	35mm	Φ4.0mm	2	SF17
ALC16S08-100		1000mm	○4.0mm	2	SF17
ALC16S08-200		2000mm	○4.0mm	4	SF17

# LED Linear Flex Mounting Channel



ALC16S07

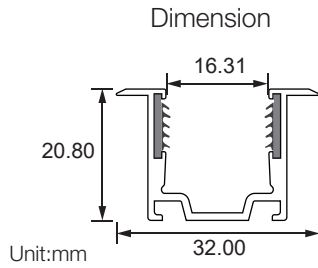

Installation Way

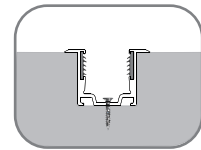

Recessed

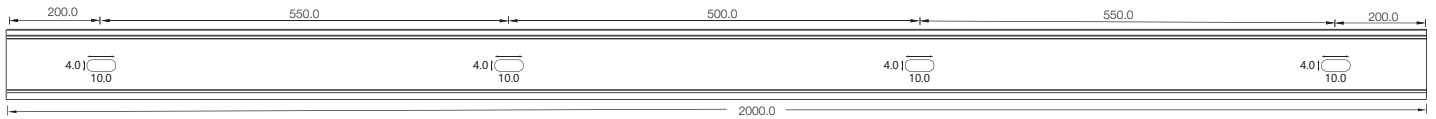
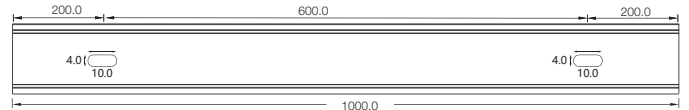
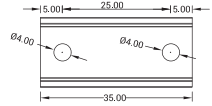

Model	W x H(mm)	Standard Length	Screw Holes	Holes Numbers	Suitable Product
ALC16S07-035	22.0*22.8	35mm	Φ4.0mm	2	SF17
ALC16S07-100		1000mm	○4.0mm	2	SF17
ALC16S07-200		2000mm	○4.0mm	4	SF17



ALC16H02

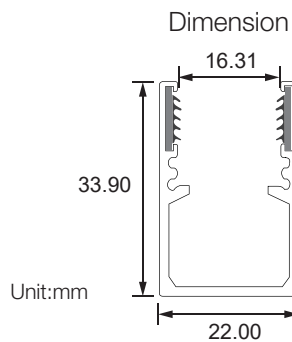

Installation Way

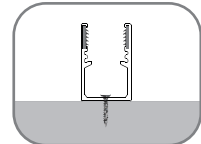

Surface Mounted

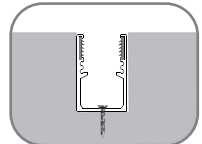

Recessed

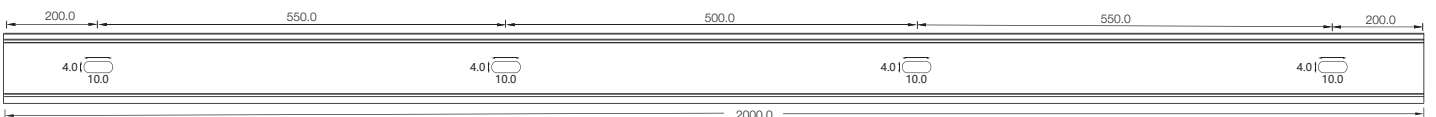
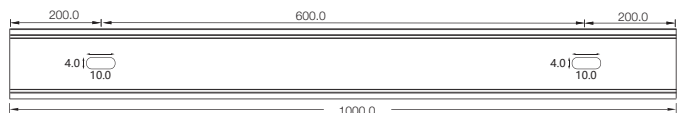
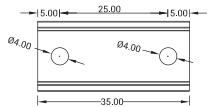

Model	W x H(mm)	Standard Length	Screw Holes	Holes Numbers	Suitable Product
ALC16H02-035	22.00*33.90	35mm	Φ4.0mm	2	SF17
ALC16H02-100		1000mm	○4.0mm	2	SF17
ALC16H02-200		2000mm	○4.0mm	4	SF17

# LED Linear Flex Mounting Channel

## 2. Flexible Aluminum Channel

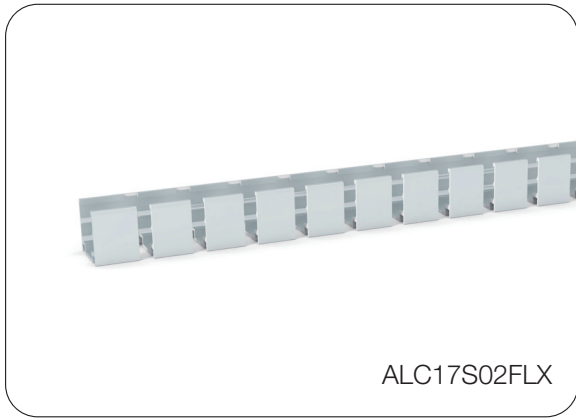

Dimension

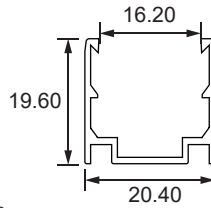

Unit:mm

Installation Way

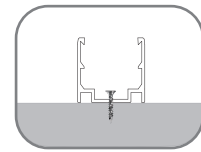

Surface Mounted

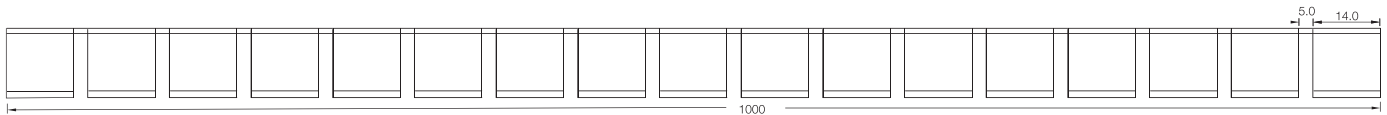
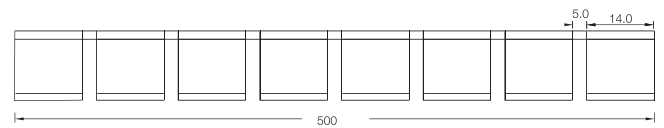

Model	W x H(mm)	Standard Length	Suitable Product
ALC17S02FLX-05	20.4*19.60	500mm	SF17
ALC17S02FLX-10		1000mm	SF17

## 3. Plastic Channel



Dimension

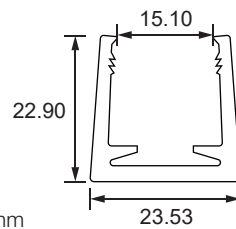

Unit:mm

Installation Way

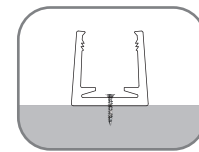

Surface Mounted

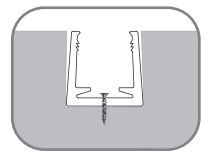

Recessed

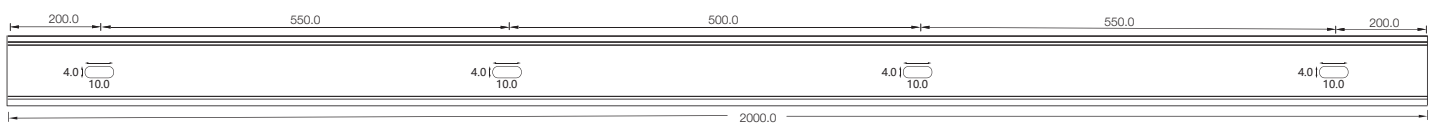
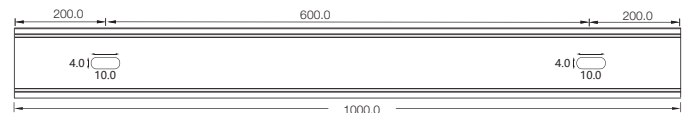
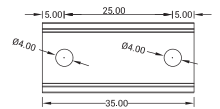

Model	W x H(mm)	Standard Length	Screw Holes	Holes Numbers	Suitable Product
PC16/17S02-T-100	23.53*22.90	1000mm	Φ4.0mm	2	SF17



# LED Linear Flex Mounting Channel

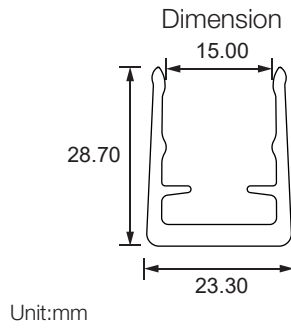

Installation Way

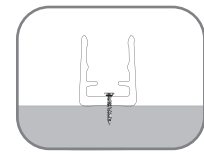

Surface Mounted

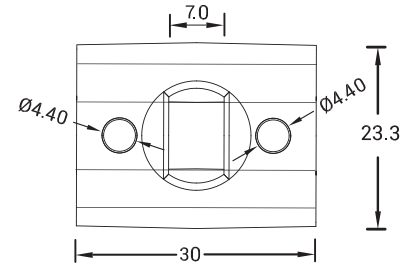

Model	W x H(mm)	Standard Length	Screw Holes	Holes Numbers	Suitable Product
SJJ-ZSH-008-PC	23.3*28.7	30mm	Ø4.40mm	2	SF17

## 4. Stainless Steel Channel

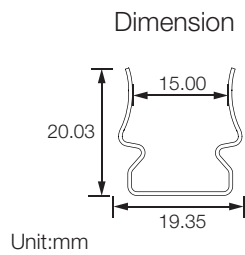
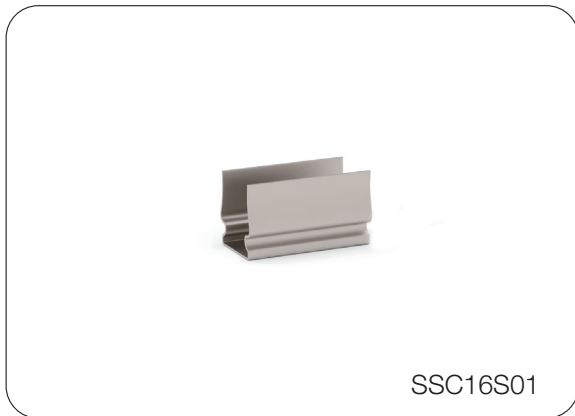

Installation Way

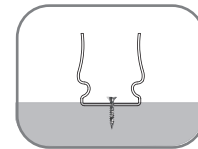

Surface Mounted

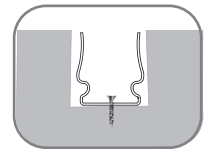

Recessed

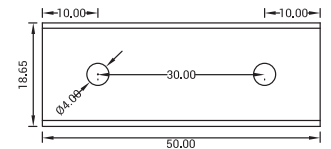

Model	W x H(mm)	Standard Length	Material	Screw Holes	Holes Numbers	Suitable Product
SSC16S01-05	19.35*20.03	50mm	Stainless Steel 316L	Ø4.0mm	2	SF17

# LED Linear Flex Mounting Channel

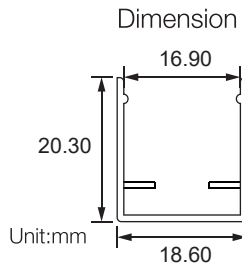

Installation Way

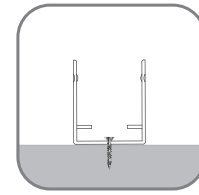

Surface Mounted

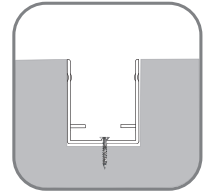

Recessed

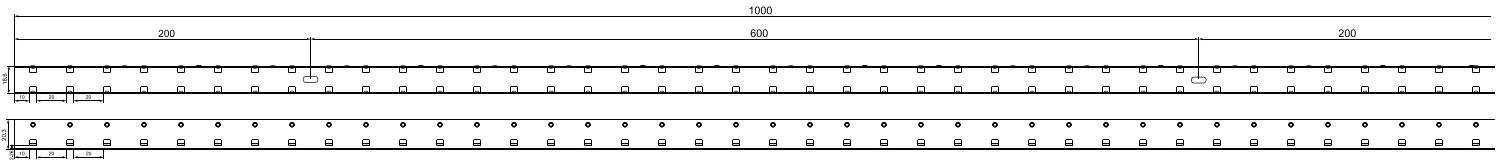

Model	W x H(mm)	Standard Length	Material	Screw Holes	Holes Numbers	Suitable Product
SSC16S02-100	18.60*20.3	1000mm	Stainless Steel 316L	4.0x10mm	2	SF17

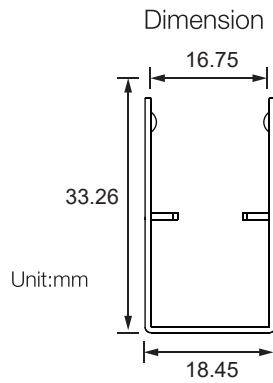

Installation Way

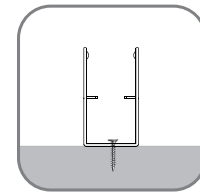

Surface Mounted

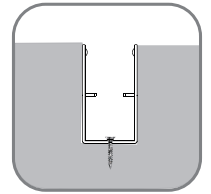

Recessed

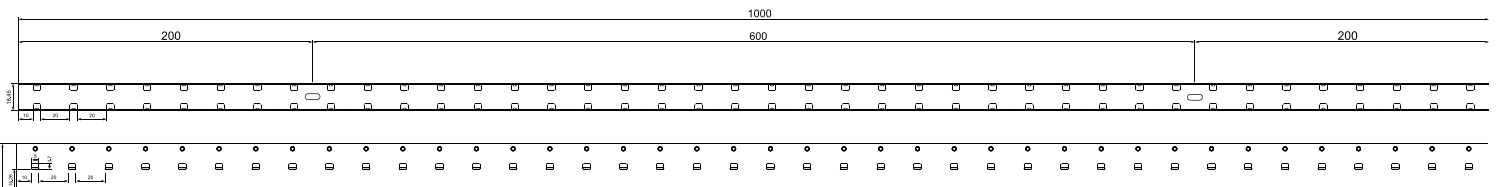

Model	W x H(mm)	Standard Length	Material	Screw Holes	Holes Numbers	Suitable Product
SSC16H01-100	18.45*33.26	1000mm	Stainless Steel 316L	4.0x10mm	2	SF17

# LED Linear Flex Mounting Channel

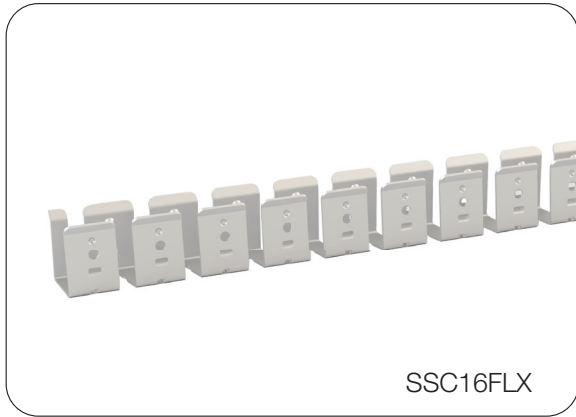

Dimension

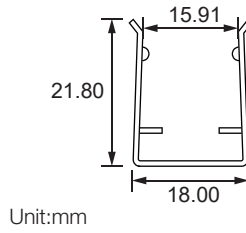

Installation Way

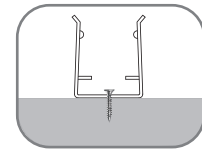

Surface Mounted

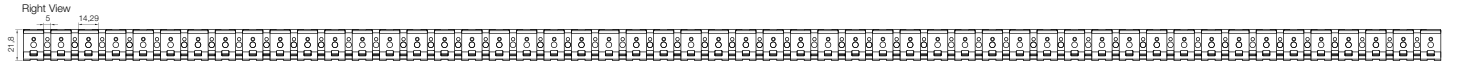

Model	W x H(mm)	Standard Length	Material	Suitable Product
SSC16FLX01	18.00*21.80	100mm	Stainless Steel 316L	SF17
SSC16FLX03		300mm	Stainless Steel 316L	SF17
SSC16FLX05		500mm	Stainless Steel 316L	SF17
SSC16FLX10		1000mm	Stainless Steel 316L	SF17

# Artflex LED Linear Flex Mounting Channel

## Glare-Free Kit

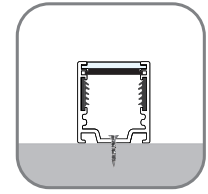
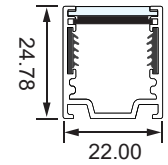
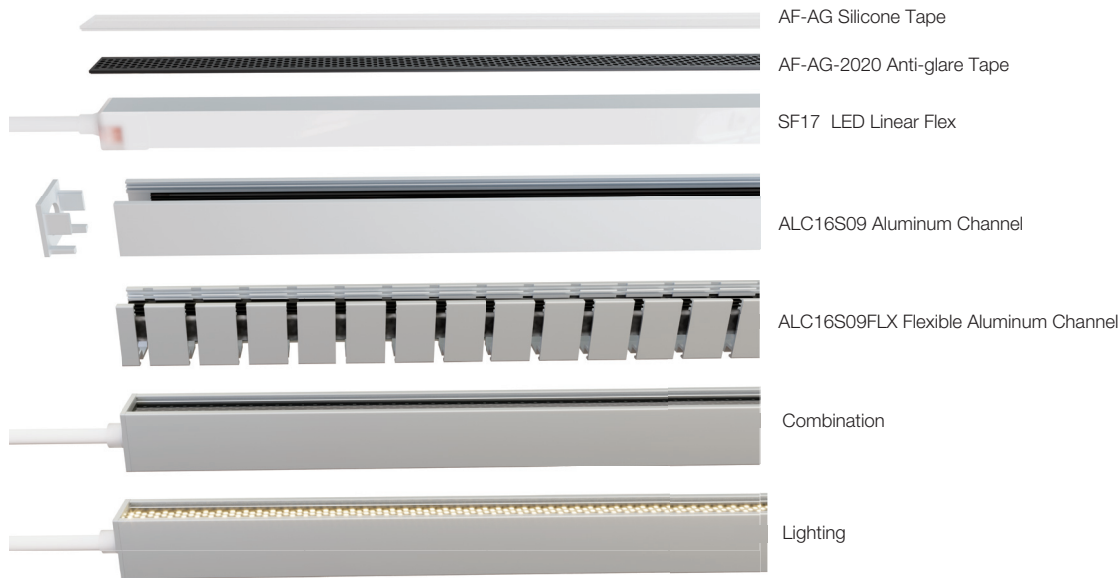

Surface Mounted

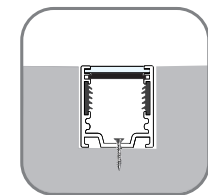

Recessed

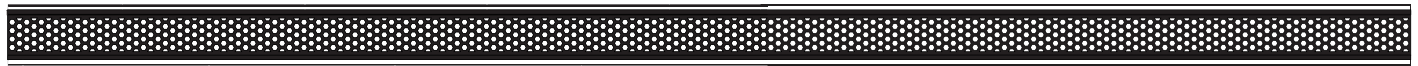

Model	W x H(mm)	Standard Length	Screw Holes	Holes Numbers	Suitable Product
AF-AG-2020-ALC16S09	22.00*24.78	1000mm	4.0x10mm	2	SF17

## Artflex Kit

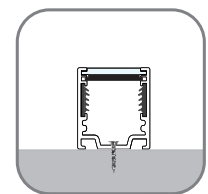
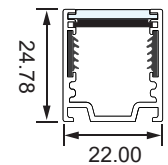
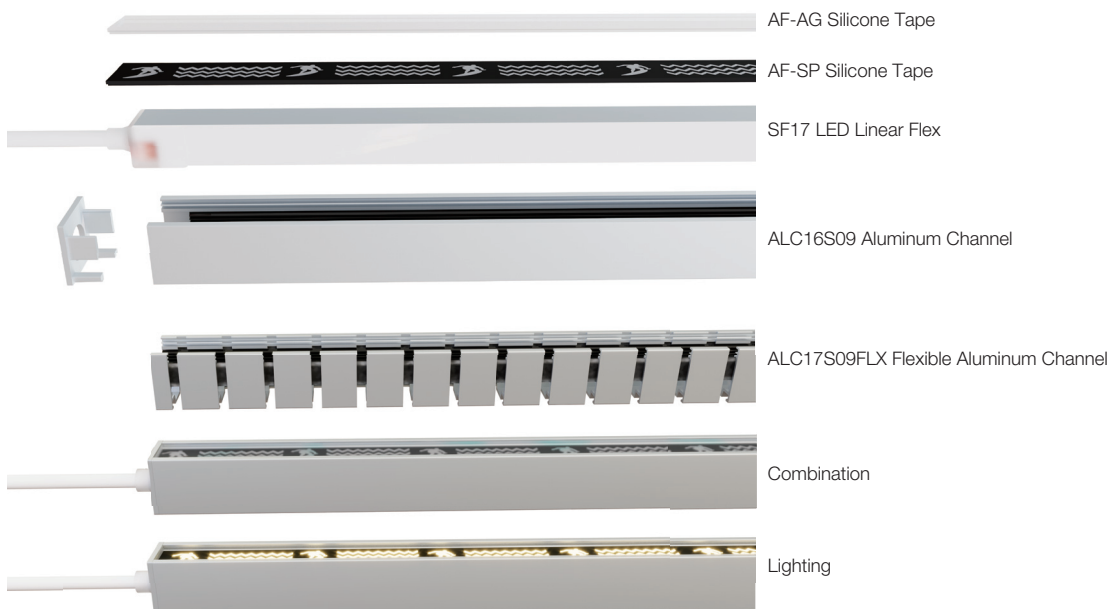

Surface Mounted

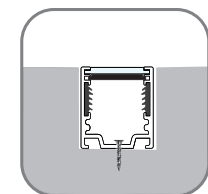

Recessed



Model	W x H(mm)	Standard Length	Screw Holes	Holes Numbers	Suitable Product
AF-SP-ALC16S09	22.00*24.78	1000mm	4.0x10mm	2	SF17

# Artflex LED Linear Flex Mounting Channel

## ColorShift Kit

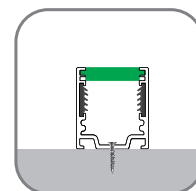
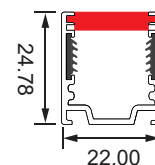
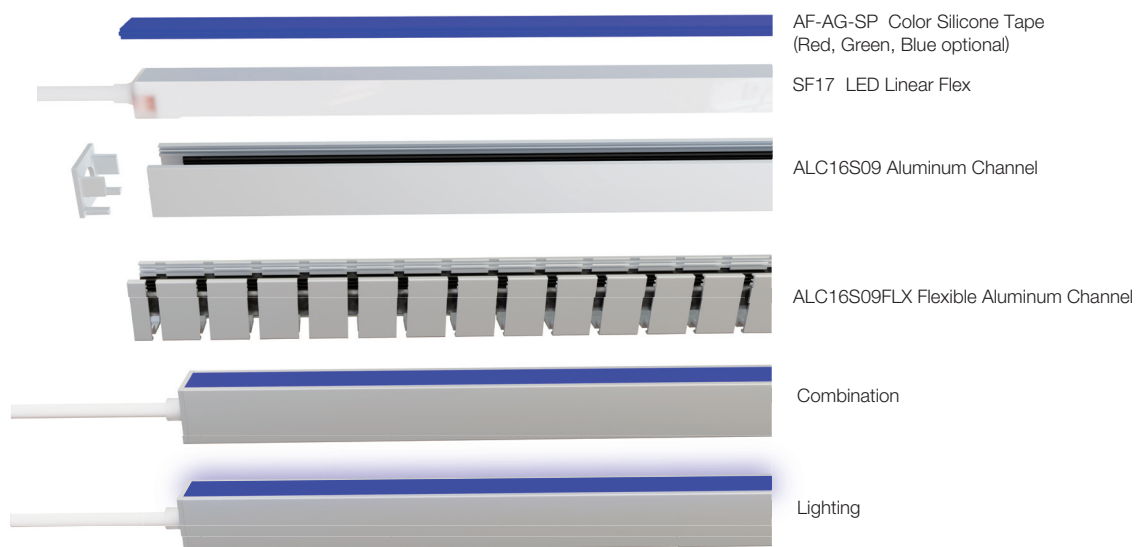

Surface Mounted

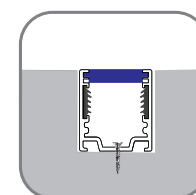

Recessed



Model	W x H(mm)	Standard Length	Screw Holes	Holes Numbers	Suitable Product
AF-AG-SP-ALC16S09	22.00*24.78	1000mm	○4.0x10mm	2	SF17

# Product Packing Details



## Standard : Carton (White Carton+Paper Reel Inside)

Product	Max.length/Reel	Carton Size	Net Weight	Gross Weight
F15/SF15	30m	35*35*19cm	12.0kg	13.6kg
F16/SF16	28m	35*35*19cm	12.9kg	14.5kg
SF17	28m	35*35*19cm	12.9kg	14.5kg
SF18	28m	35*35*19cm	12.9kg	14.5kg
F21/SF21	20m	35*35*19cm	10.4kg	12.0kg
SF10	35m	35*35*19cm	11.2kg	12.8kg
SF09	45m	35*35*19cm	7.7kg	9.3kg
SF08	60m	35*35*19cm	14.4kg	16.0kg
SF06	60m	35*35*19cm	14.4kg	16.0kg



## Standard : Carton (White Carton+ Roll up packing Inside)

Product	Coiling Max. length	Quantity (Roll)	Carton Size	Net Weight	Gross Weight
SP01	10m	10	35*35*19cm	20.0kg	21.6kg
SP05	11m	10	35*35*19cm	19.8kg	21.4kg
SF05	11m	10	35*35*19cm	18.0kg	19.6kg
SF06	8m	14	35*35*19cm	26.8kg	28.4kg
SF08	8m	14	35*35*19cm	26.8kg	28.4kg
SF09	8m	10	35*35*19cm	14.4kg	16.0kg
SF10	6m	11	35*35*19cm	21.2kg	22.8kg
F15/SF15	6m	7	35*35*19cm	16.8kg	18.4kg
F16/SF16	4.5m	9	35*35*19cm	18.7kg	20.3kg
SF17	4.5m	9	35*35*19cm	18.7kg	20.3kg
SF18	4.5m	9	35*35*19cm	18.7kg	20.3kg
F21/SF21	4.5m	9	35*35*19cm	21.0kg	22.6kg
SF24	13m	2	41*41*19cm	15.6kg	17.5kg

# Product Packing Details



Custom : Carton (White Box+Plastic Plate Inside)

Product	Packing 1				Packing 2			
	Packing 1 Max. Length	Quantity (Plate)	Carton Size	Gross Weight	Packing 2 Max. Length	Quantity (Plate)	Carton Size	Gross Weight
F15/SF15	5m	1	41*41*5cm	2.5kg	10m	1	57*48*6cm	5.0kg
		4	41*41*19cm	10.6kg		5	57*48*19cm	25.0kg
F16/SF16	5m	1	41*41*5cm	2.5kg	10m	1	63*53*6cm	5.0kg
		4	41*41*19cm	10.0kg		3	63*53*16cm	15.0kg
SF17	5m	1	41*41*5cm	2.5kg	10m	1	63*53*6cm	5.0kg
		4	41*41*19cm	10.6kg		3	63*53*16cm	15.0kg
SF18	5m	1	41*41*5cm	2.5kg	10m	1	63*53*6cm	5.0kg
		4	41*41*19cm	10.6kg		3	63*53*16cm	15.0kg
F21/SF21	5m	1	41*41*5cm	3.1kg	10m	1	63*53*6cm	6.2kg
		4	41*41*19cm	13.0kg		3	63*53*16cm	18.6kg
SP01	10m	1	41*41*5cm	2.6kg	20m	1	57*48*6cm	5.0kg
		4	41*41*19cm	11.0kg		5	57*48*19cm	25.0kg
SP05	10m	1	41*41*5cm	2.4kg	20m	1	57*48*6cm	3.6kg
		4	41*41*19cm	9.6kg		5	57*48*19cm	18.0kg
SF05	10m	1	41*41*5cm	2.0kg	20m	1	57*48*6cm	4.0kg
		4	41*41*19cm	8.0kg		5	57*48*19cm	20.0kg
SF06	7m	1	41*41*5cm	2.3kg	14m	1	57*48*6cm	4.4kg
		4	41*41*19cm	9.2kg		5	57*48*19cm	22.0kg
SF08	7m	1	41*41*5cm	2.3kg	14m	1	57*48*6cm	4.4kg
		4	41*41*19cm	9.2kg		5	57*48*19cm	22.0kg
SF09	9m	1	41*41*5cm	2.0kg	18m	1	57*48*6cm	3.9kg
		4	41*41*19cm	8.0kg		5	57*48*19cm	19.5kg
SF10	5m	1	41*41*5cm	2.3kg	10m	1	57*48*6cm	4.2kg
		4	41*41*19cm	9.2kg		5	57*48*19cm	21.0kg
SF24	5m	1	57*48*6cm	2.3kg	10m	1	63*53*6cm	4.2kg
		4	57*48*19cm	9.2kg		5	63*53*16cm	21.0kg
SF33	3m	1	63*53*6cm	3.4kg	10m	1	85*73*6cm	11.5kg
		3	63*53*16cm	10.2kg		2	85*73*11cm	23.0kg
SF34	3m	1	63*53*6cm	3.2kg	10m	1	85*73*6cm	11.0kg
		3	63*53*16cm	9.6kg		2	85*73*11cm	22.0kg